

SILICONE LED NEON LIGHT

矽膠霓虹燈帶

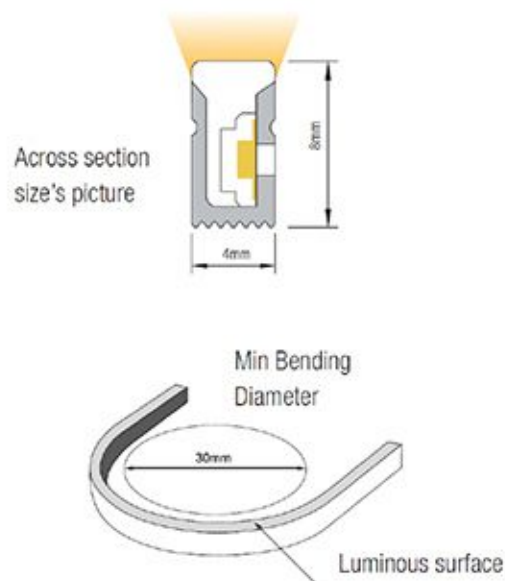



Model 型號 BT-N0408

Size 尺寸(mm) W4*H8*5000 (mm)

Input Voltage 輸入電壓 DC24V

Min cut 最小裁剪(mm) 25 (mm)

Typ power 典型功率(w/m) 6 (w/m)

Lumens 光通量(lm/m) 42 (lm/m)

CCT/Color 色溫/顏色 2100K、2400K、2600K、3000K、3500K、4200K、5300K

CRI 演色性 >90

Min bending radius
最小折彎半徑 (mm) 30 (mm)

IP防護等級 IP67

安裝配件：

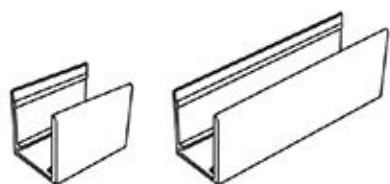

Flat mounting of clip / aluminum groove 安裝鋁槽



Moldable groovez 可造型安裝槽

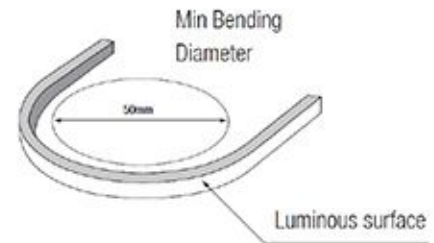
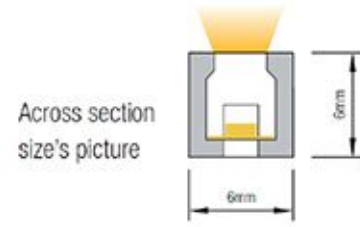
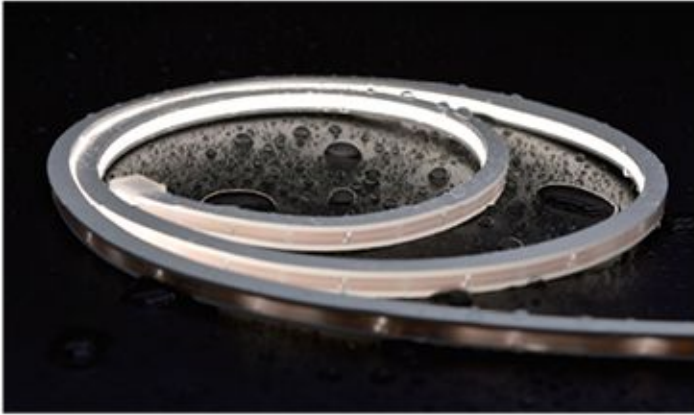

Model 型號	BT-N0606
Size 尺寸(mm)	W6*H6*5000 (mm)
Input Voltage 輸入電壓	DC24V
Min cut 最小裁剪(mm)	25 (mm)
Typ power 典型功率(w/m)	5 (w/m)
Lumens 光通量(lm/m)	58 (lm/m)
CCT/Color 色溫/顏色	1700K、2200K、2400K、2600K、2800K、3200K、3800K、4400K、5600K
CRI 演色性	>90
Min bending radius 最小折彎半徑 (mm)	50 (mm)
IP防護等級	IP67

安裝配件：

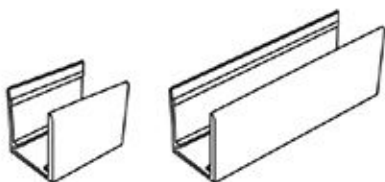

Flat mounting of clip / aluminum groove 安裝鋁槽



Moldable groovez 可造型安裝槽

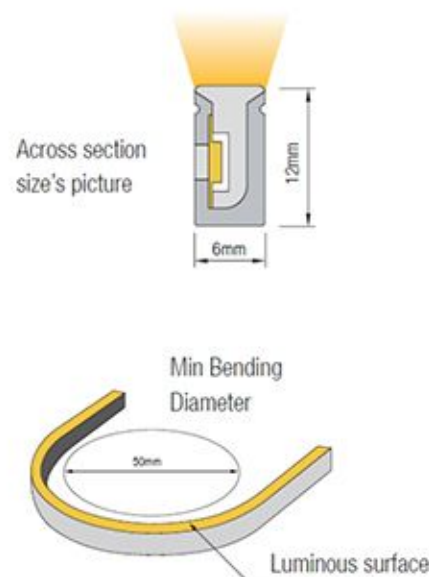
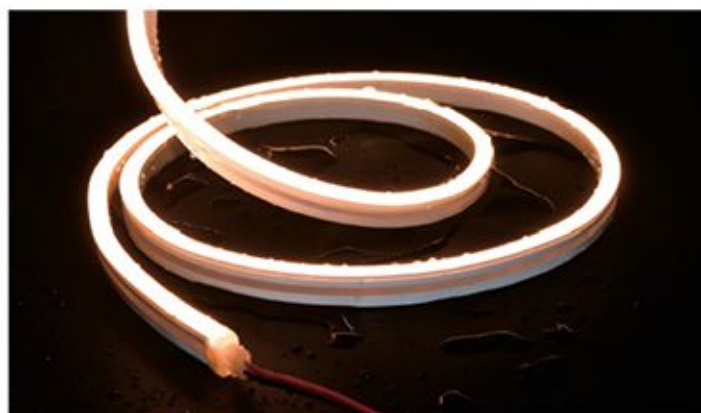

Model 型號	BT-N0612
Size 尺寸(mm)	W6*H12*5000 (mm)
Input Voltage 輸入電壓	DC24V
Min cut 最小裁剪(mm)	50 (mm)
Typ power 典型功率(w/m)	5 (w/m)
Lumens 光通量(lm/m)	37.2 (lm/m)
CCT/Color 色溫/顏色	2100K、2400K、2700K、3000K、3500K、4000K、5000K、6000K、TW、R、G、B、AMBER、PINK、RGB-R、RGB-G、RGB-B、RGB
CRI 演色性	>90
Min bending radius 最小折彎半徑 (mm)	50 (mm)
IP防護等級	IP67

安裝配件：

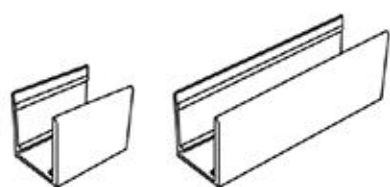

Flat mounting of clip / aluminum groove 安裝鋁槽

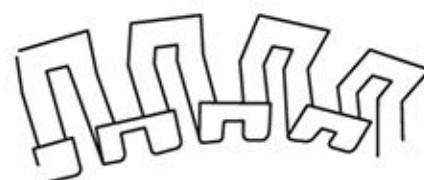

Moldable groovez 可造型安裝槽

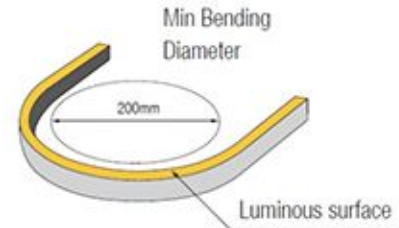
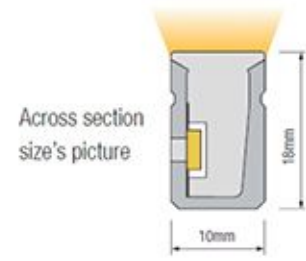

Model 型號	BT-N1018
Size 尺寸(mm)	W10*H18*5000 (mm)
Input Voltage 輸入電壓	DC24V
Min cut 最小裁剪(mm)	50 (mm)
Typ power 典型功率(w/m)	5 (w/m)
Lumens 光通量(lm/m)	35.7 (lm/m)
CCT/Color 色溫/顏色	2100K、2400K、2700K、3000K、3500K、4000K、5000K、6000K、TW、R、G、B、AMBER、PINK、RGB-R、RGB-G、RGB-B、RGB
CRI 演色性	>90
Min bending radius 最小折彎半徑 (mm)	200 (mm)
IP防護等級	IP67

安裝配件：

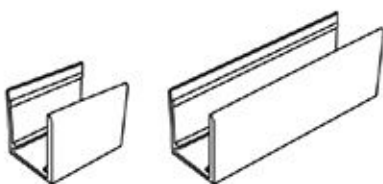

Flat mounting of clip / aluminum groove 安裝鋁槽



Moldable groovez 可造型安裝槽

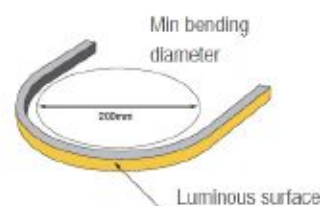
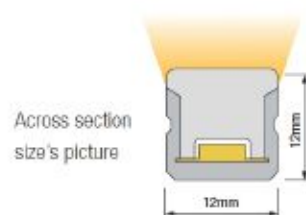

Model 型號	BT-N1212	
Size 尺寸(mm)	W12*H12*5000 (mm)	
Input Voltage 輸入電壓	DC24V	
Min cut 最小裁剪(mm)	50 (mm)	
Typ power 典型功率(w/m)	5 (w/m)	10 (w/m)
Lumens 光通量(lm/m)	69.4 (lm/m)	67.7 (lm/m)
CCT/Color 色溫/顏色	2100K、2400K、2700K、3000K、3500K、4000K、5000K、6000K、TW、R、G、B、AMBER、PINK、RGB-R、RGB-G、RGB-B、RGB	
CRI 演色性	>90	
Min bending radius 最小折彎半徑 (mm)	200 (mm)	
IP防護等級	IP67	

安裝配件：

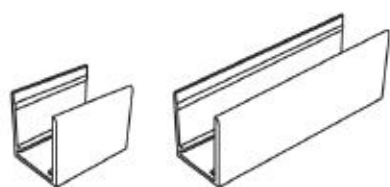

Flat mounting of clip / aluminum groove 安裝鋁槽

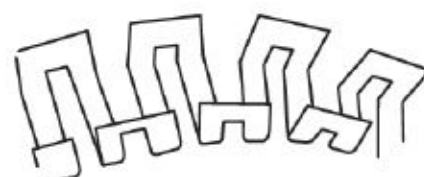

Moldable groovez 可造型安裝槽

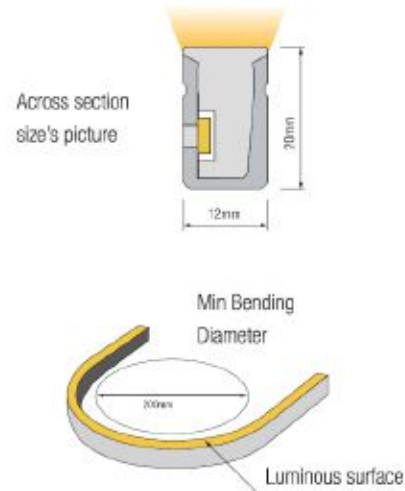

Model 型號 BT-N1220

Size 尺寸(mm) W12*H20*5000 (mm)

Input Voltage 輸入電壓 DC24V

Min cut 最小裁剪(mm) 50 (mm)

Typ power 典型功率(w/m) 5 (w/m) 10 (w/m) 15 (w/m)

Lumens 光通量(lm/m) 34 (lm/m) 33.6 (lm/m) 31.3 (lm/m)

CCT/Color 色溫/顏色 2100K、2400K、2700K、3000K、3500K、4000K、5000K、6000K、TW、R、G、B、AMBER、PINK、RGB-R、RGB-G、RGB-B、RGB

CRI 演色性 >90

Min bending radius 最小折彎半徑 (mm) 200 (mm)

IP防護等級 IP67

安裝配件：

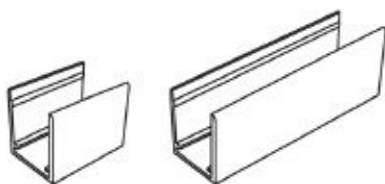

Flat mounting of clip / aluminum groove 安裝鋁槽



Moldable groovez 可造型安裝槽

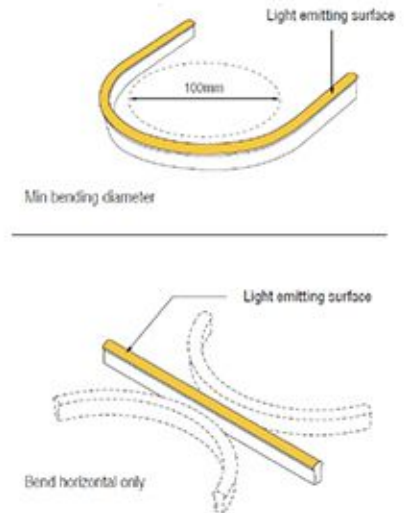
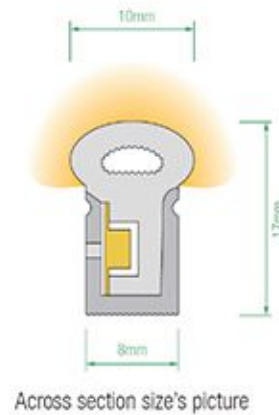

Model 型號	BT-N0817	
Size 尺寸(mm)	W8*H17*5000 (mm)	
Input Voltage 輸入電壓	DC24V	
Min cut 最小裁剪(mm)	50 (mm)	
Typ power 典型功率(w/m)	5 (w/m)	10 (w/m)
Lumens 光通量(lm/m)	34.8 (lm/m)	34 (lm/m)
CCT/Color 色溫/顏色	2100K、2400K、2700K、3000K、3500K、4000K、5000K、6000K、TW、R、G、B、AMBER、PINK、RGB-R、RGB-G、RGB-B、RGB	
CRI 演色性	>90	
Min bending radius 最小折彎半徑 (mm)	100 (mm)	
IP防護等級	IP67	

安裝配件：

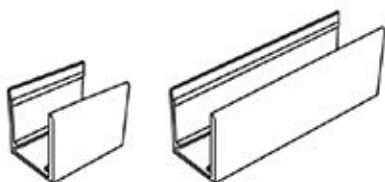

Flat mounting of clip / aluminum groove 安裝鋁槽



Moldable groovez 可造型安裝槽

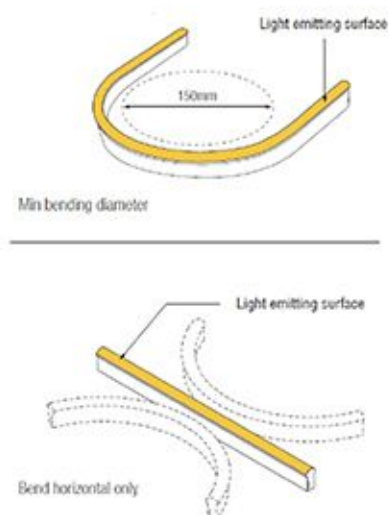
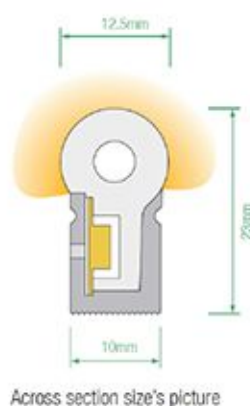

Model 型號	BT-N1023		
Size 尺寸(mm)	W10*H23*5000 (mm)		
Input Voltage 輸入電壓	DC24V		
Min cut 最小裁剪(mm)	50 (mm)		
Typ power 典型功率(w/m)	5 (w/m)	10 (w/m)	15 (w/m)
Lumens 光通量(lm/m)	39.4 (lm/m)	38.7 (lm/m)	36.1 (lm/m)
CCT/Color 色溫/顏色	2100K、2400K、2700K、3000K、3500K、4000K、5000K、6000K、TW、R、G、B、AMBER、PINK		
CRI 演色性	>90		
Min bending radius 最小折彎半徑 (mm)	150 (mm)		
IP防護等級	IP67		

安裝配件：

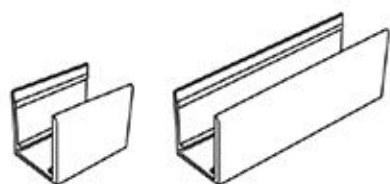

Flat mounting of clip / aluminum groove 安裝鋁槽



Moldable groovez 可造型安裝槽

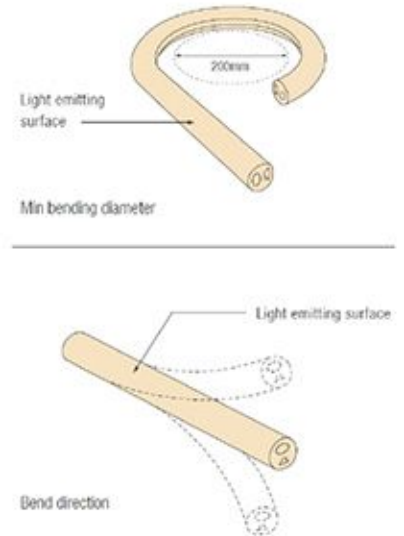
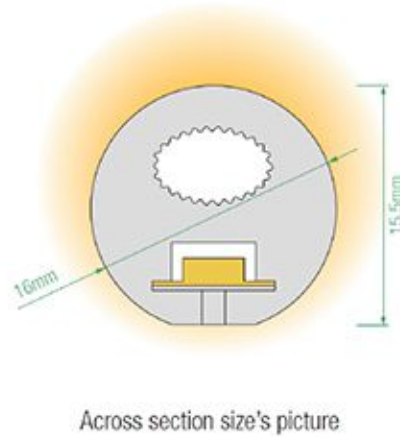
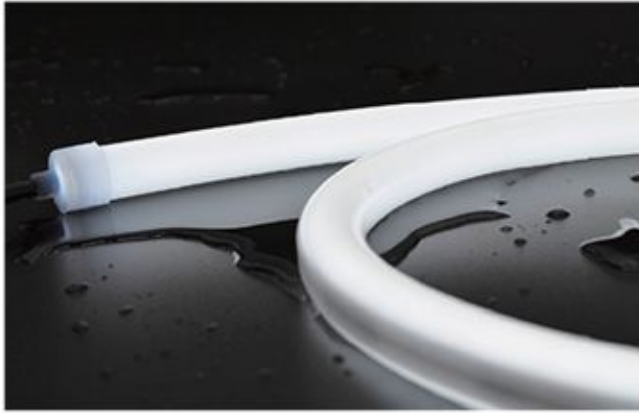

Model 型號	BT-ND16	
Size 尺寸(mm)	D16*5000 (mm)	
Input Voltage 輸入電壓	DC24V	
Min cut 最小裁剪(mm)	50 (mm)	
Typ power 典型功率(w/m)	5 (w/m)	10 (w/m)
Lumens 光通量(lm/m)	73 (lm/m)	70.7 (lm/m)
CCT/Color 色溫/顏色	2100K、2400K、2700K、3000K、3500K、4000K、5000K、6000K、TW、R、G、B、AMBER、PINK、RGB-R、RGB-G、RGB-B、RGB	
CRI 演色性	>90	
Min bending radius 最小折彎半徑 (mm)	200 (mm)	
IP防護等級	IP67	

安裝配件：

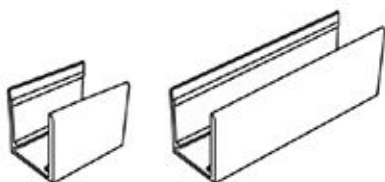

Flat mounting of clip / aluminum groove 安裝鋁槽



Moldable groovez 可造型安裝槽

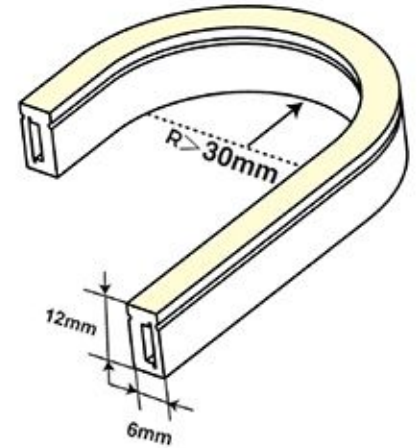
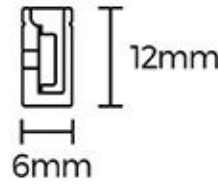

Model 型號	BT-NMS0612	
Size 尺寸(mm)	W6*H12*5000 (mm)	
Input Voltage 輸入電壓	DC12V/24V	
Min cut 最小裁剪(mm)	Single color 25/50 (mm)	
Typ power 典型功率(w/m)	9.6 (white light)	8.8 (RGBY)
Lumens 光通量(lm/m)	230/240/240/220/240	
CCT/Color 色溫/顏色	2300K、2700K、3000K、4000K、4500K、 R、G、B、Y	
CRI 演色性	>80	
Min bending radius 最小折彎半徑 (mm)	>30 (mm)	
IP防護等級	IP67	

安裝配件：

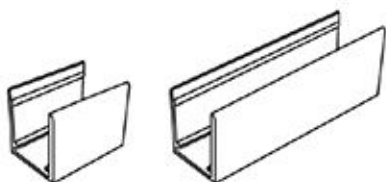

Flat mounting of clip / aluminum groove 安裝鋁槽



Moldable groovez 可造型安裝槽

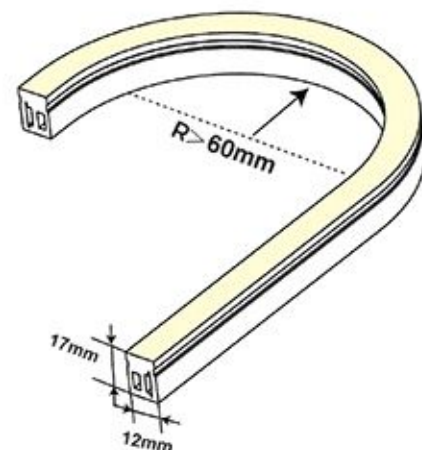
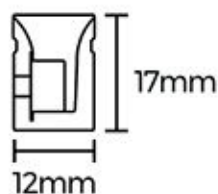

Model 型號	BT-NMS1217
Size 尺寸(mm)	W12*H17*5000 (mm)
Input Voltage 輸入電壓	DC24V
Min cut 最小裁剪(mm)	Single color 50 / RGB 83 (mm)
Typ power 典型功率(w/m)	9.6 (white light) 8 (RGBY) 12 (RGB)
Lumens 光通量(lm/m)	370/380/360/360
CCT/Color 色溫/顏色	2300K、2700K、3000K、4000K、R、G、B、Y RGB
CRI 演色性	> 80
Min bending radius 最小折彎半徑 (mm)	> 60 (mm)
IP防護等級	IP67

安裝配件：

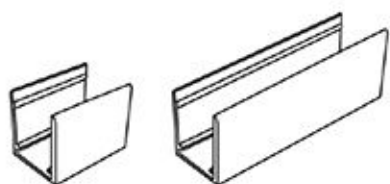

Flat mounting of clip / aluminum groove 安裝鋁槽



Moldable groovez 可造型安裝槽

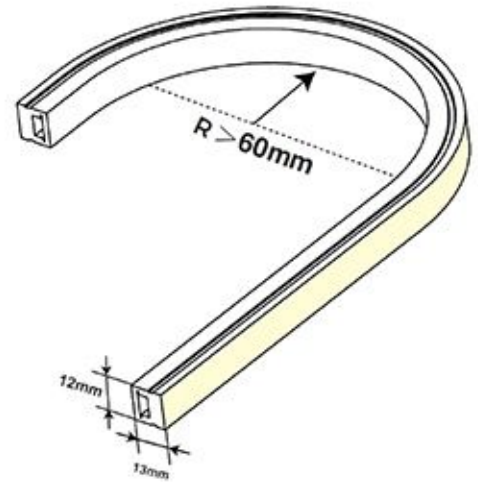
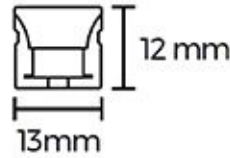

Model 型號	BT-NMT1312		
Size 尺寸(mm)	W13*H12*5000 (mm)		
Input Voltage 輸入電壓	DC24V		
Min cut 最小裁剪(mm)	Single color 50 / RGB 83 (mm)		
Typ power 典型功率(w/m)	9.6 (white light)	8 (RGBY)	12 (RGB)
Lumens 光通量(lm/m)	550/600/600/620/620		
CCT/Color 色溫/顏色	2300K、2700K、3000K、4000K、4500K、 R、G、B、Y、RGB		
CRI 演色性	>80		
Min bending radius 最小折彎半徑 (mm)	>60 (mm)		
IP防護等級	IP67		

安裝配件：

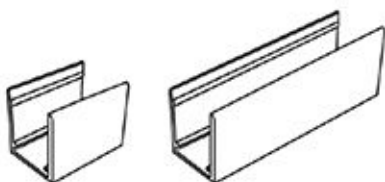

Flat mounting of clip / aluminum groove 安裝鋁槽



Moldable groovez 可造型安裝槽

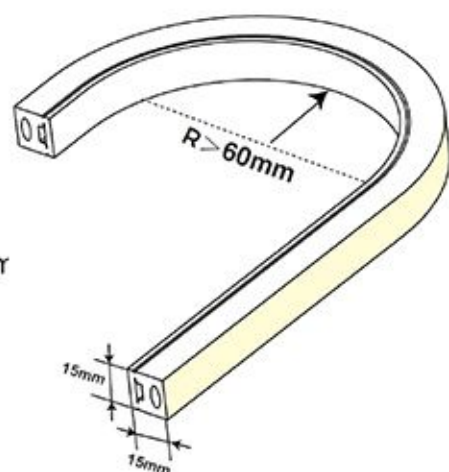
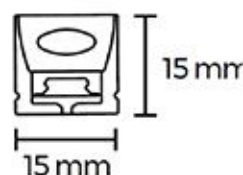

Model 型號	BT-NMT1515
Size 尺寸(mm)	W15*H15*5000 (mm)
Input Voltage 輸入電壓	DC24V
Min cut 最小裁剪(mm)	Single color 50 / RGB 83 (mm)
Typ power 典型功率(w/m)	9.6 (white light) 8 (RGBY) 12 (RGB)
Lumens 光通量(lm/m)	520/580/590/580
CCT/Color 色溫/顏色	2300K、2700K、3000K、4000K、R、G、B、Y RGB
CRI 演色性	> 80
Min bending radius 最小折彎半徑 (mm)	> 60 (mm)
IP防護等級	IP67

安裝配件：

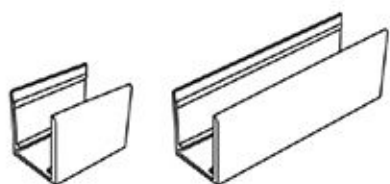

Flat mounting of clip / aluminum groove 安裝鋁槽



Moldable groovez 可造型安裝槽

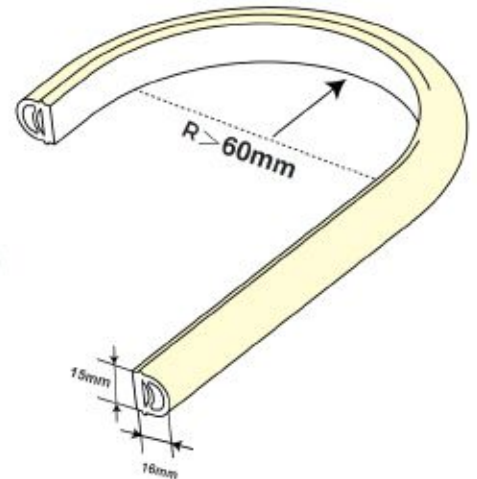
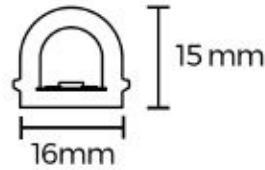

Model 型號	BT-NNT1615
Size 尺寸(mm)	W16*H15*5000 (mm)
Input Voltage 輸入電壓	DC24V
Min cut 最小裁剪(mm)	Single color 41.6 / RGB 50 (mm)
Typ power 典型功率(w/m)	11 (white light) 12 (RGB)
Lumens 光通量(lm/m)	750/780/800/820/800
CCT/Color 色溫/顏色	2300K、2700K、3000K、3700K、5000K、RGB
CRI 演色性	>80
Min bending radius 最小折彎半徑 (mm)	>60 (mm)
IP防護等級	IP67

安裝配件：

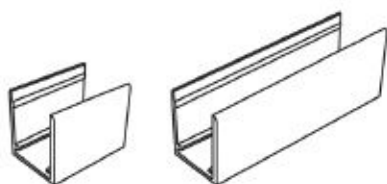

Flat mounting of clip / aluminum groove 安裝鋁槽



Moldable groovez 可造型安裝槽

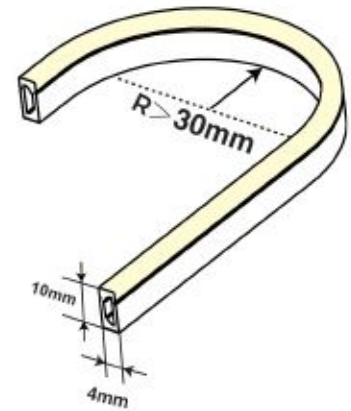
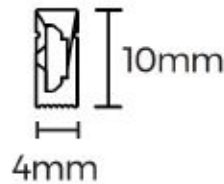

Model 型號	BT-NTS0410
Size 尺寸(mm)	W4*H10*5000 (mm)
Input Voltage 輸入電壓	DC12V/24V
Min cut 最小裁剪(mm)	17.8 / 41.6 (mm)
Typ power 典型功率(w/m)	7.2 (w/m)
Lumens 光通量(lm/m)	240/290/300/300
CCT/Color 色溫/顏色	2300K、2700K、3000K、4000K、R、G、B、Y
CRI 演色性	> 80
Min bending radius 最小折彎半徑 (mm)	> 30 (mm)
IP防護等級	IP67

安裝配件：

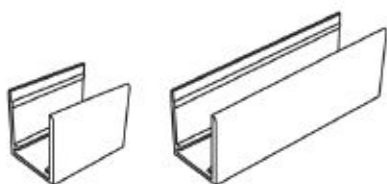

Flat mounting of clip / aluminum groove 安裝鋁槽



Moldable groovez 可造型安裝槽